

B T S コネクタ

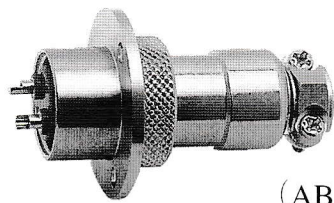

(A)

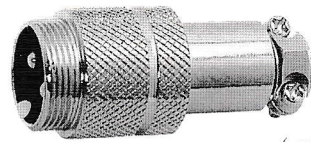

(C)

○ プラグ (A)

○ アダプタ (C)

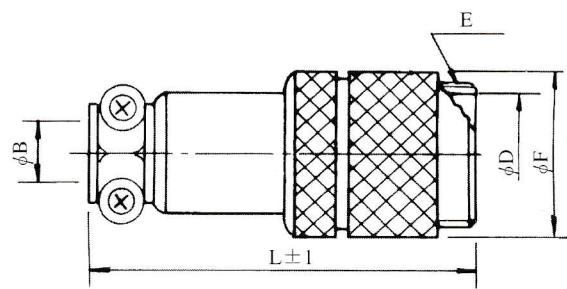
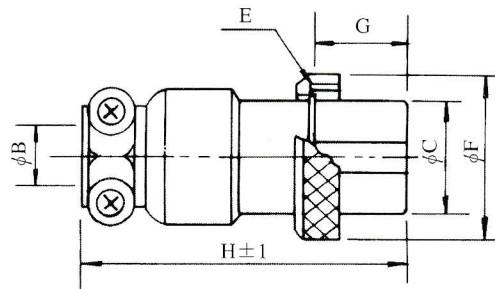

○ レセプタクル (B)

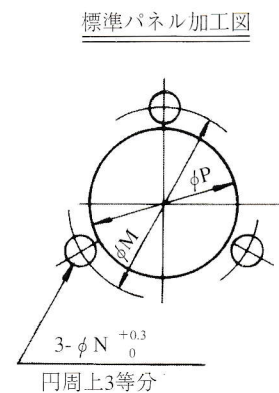
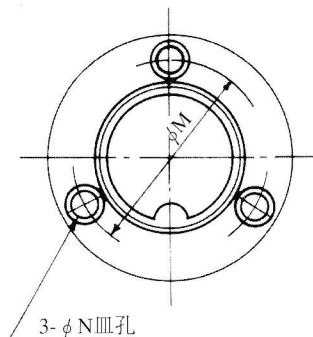
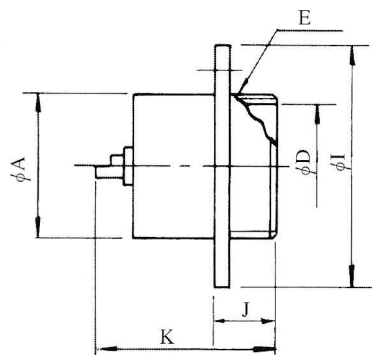

	A	B	C	D	E	F	G	H	I	J	K	L	M	N	P
B T S-12	14	6	12	12.5	M15.5×1	18	12	38.5	23	6.5	23	44.5	19	2.1	15
B T S-16	19	8	15.5	16.3	M19×1	22	12	43	32	8	24	51	25.5	3.2	20
B T S-21	25	10	21	22	M25×1	28	13	47.5	41	7.5	27	58.5	33	3.2	26
B T S-25	29	12	25	26	M29×1	32	13	55	46	7.5	27	66	37	3.2	30

● 定格表

	2極	3極	4極	5極	6極	7極	8極	9極	10極	12極	15極
BTS-12	125V 5A	125V 3A	—	—	—	—	—	—	—	—	—
BTS-16	125V 8A	125V 8A	125V 8A	125V 5A	125V 3A	125V 3A	—	—	—	—	—
BTS-21	250V10A	250V10A	250V10A	250V 7A	—	—	—	—	—	—	—
BTS-25	250V15A	250V15A	250V15A	250V15A	250V15A	250V15A	250V 7A	250V 7A	250V 7A	250V 5A	250V 3A

● 型式認可番号

	2 極	3 極	4 極	5 極
B T S-16 A	▽41-6541	▽41-6542	▽41-6543	▽41-6544
B T S-21 A	▽41-6338	▽41-6422	▽41-6423	▽41-6455
B T S-25 A	▽41-6424	▽41-6425	▽41-6428	▽41-6429